

NeoVision120 SideFlex

120VAC Neon LED Tape Specification Sheet

GM Lighting®

Project Name	Type
Catalog #	Date

PRODUCT OVERVIEW

120VAC operation for higher power and brightness from one linear run. Flexible linear “neon” tape is designed for applications that require ultra-rich light and color saturation that is characteristic of neon. SideFlex enables side-to-side bending for curvilinear lines. NeoVision120 tapes provide long, continuous runs up to 163 feet.

FEATURES

- 120VAC operation (no driver required)
- Wet location - IP65
- Multiple power feed options:
 - End Feed
 - Left or Right Side Feed
- Tape encased in UV resistant silicone
- Triac/ELV dimmable
- White and color LED options
- 120° viewing angle
- Maximum run: 163' - made to order in 12" increments

SPECIFICATIONS

ELECTRICAL

- Input: 120VAC 60Hz
- 3.4W per foot (colors)
- 4.3W per foot (white)
- PF>0.9

ENVIRONMENTAL

- Outdoor & wet location rated
- UV resistant
- Ambient operating temp:
-4°F to +113°F (-20°C to +45°C)

PHOTOMETRIC

- White: 2700K, 3000K or 4000K at 90+ CRI

WARRANTY

- 3 years

CERTIFICATION

- ETLus
UL1598 (Hardwire)
UL2388 (Plug-in)
- IP65

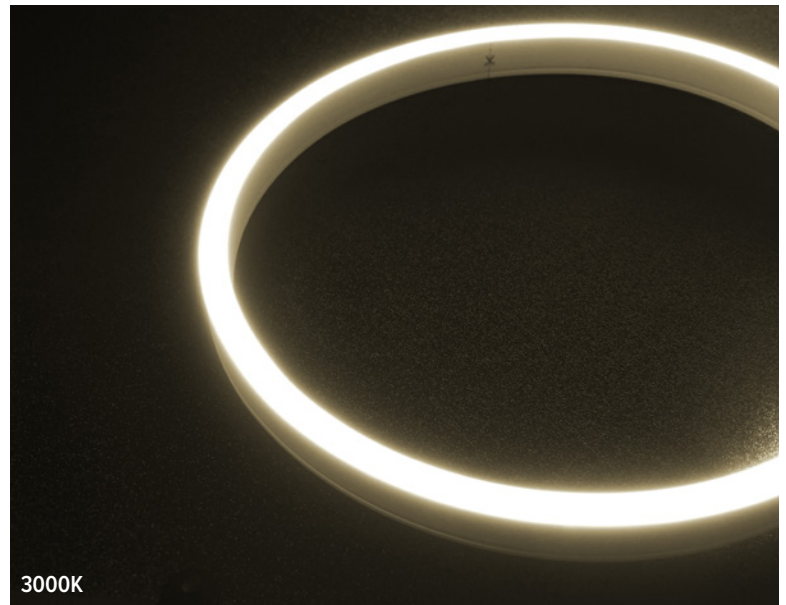

3000K

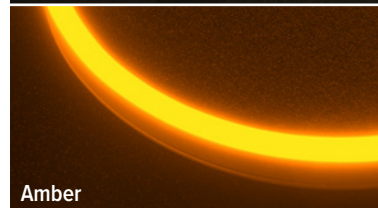

Amber

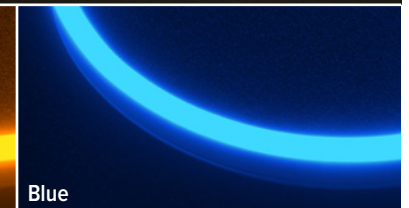

Blue

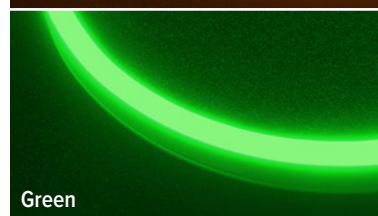

Green

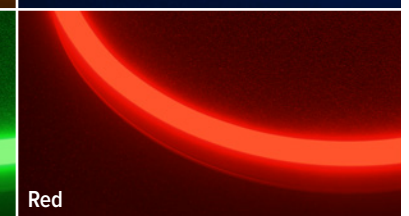

Red

ORDERING INFORMATION

1. Select Tape
2. Pick Feed
3. Pick Mounting Options
4. Pick Control Options

All **NeoVision120** tape configurations must be specified at time of order. Parts are made to order and sealed by GM Lighting at the factory only.

NeoVision120 SideFlex

120VAC Neon LED Tape Specification Sheet



All NeoVision 120 tape configurations will be cut and sealed by GM Lighting to your specifications. No field modifications allowed.

ORDERING INFORMATION

1. Select Tape

Example: NV120S-3W-30K-024 (24 ft)

XXX Length = 001 to 163 in 1 ft increments

Model	Watts/Ft	Color Temp	Length(ft)
NV120S	4W	27K (2700K)	XXX
		30K (3000K)	
		40K (4000K)	
NV120S	3W	AM (Amber)	XXX
		BL (Blue)	
		GR (Green)	
		RD (Red)	

Catalog No.	Watts/Ft Max.	Color Temp	Lumens/Ft	Max. Run
NV120S-4W-27K	4.3W	2700K	116 Lm	163 ft
NV120S-4W-30K	4.3W	3000K	121 Lm	163 ft
NV120S-4W-40K	4.3W	4000K	140 Lm	163 ft
NV120S-3W-AM	3.4W	Amber (593nm pk)	25 Lm	163 ft
NV120S-3W-BL	3.4W	Blue (465nm pk)	15 Lm	163 ft
NV120S-3W-GR	3.4W	Green (519nm pk)	79 Lm	163 ft
NV120S-3W-RD	3.4W	Red (633nm pk)	40 Lm	163 ft

ACCESSORIES

2. Pick Feed

Catalog No.	Description
NV120S-HW-8-EF	Hardwire End Feed w/Filter & 8A Fuse
NV120S-HW-8-SFL	Hardwire Side Feed Left w/Filter & 8A Fuse
NV120S-HW-8-SFR	Hardwire Side Feed Right w/Filter & 8A Fuse
NV120S-PC-8-EF	Plug-in End Feed w/Filter & 8A Fuse
NV120S-PC-8-SFL	Plug-in Side Feed Left w/Filter & 8A Fuse
NV120S-PC-8-SFR	Plug-in Side Feed Right w/Filter & 8A Fuse

3. Pick Mounting Options

Model	Description
NV120S-MC-FC	Front Clip, 20 Clips/40 Screws
NV120S-MC-A	Back Mounting Clip, 20 Clips/20 Screws
NV120S-CHL-A4	4 ft Channel with 4 Screws
NV120S-CHL-A8	8 ft Channel with 8 Screws
NV120S-FLEX-CHL-10	SideFlex 10 ft Channel with 22 Screws

All cords are 8ft long

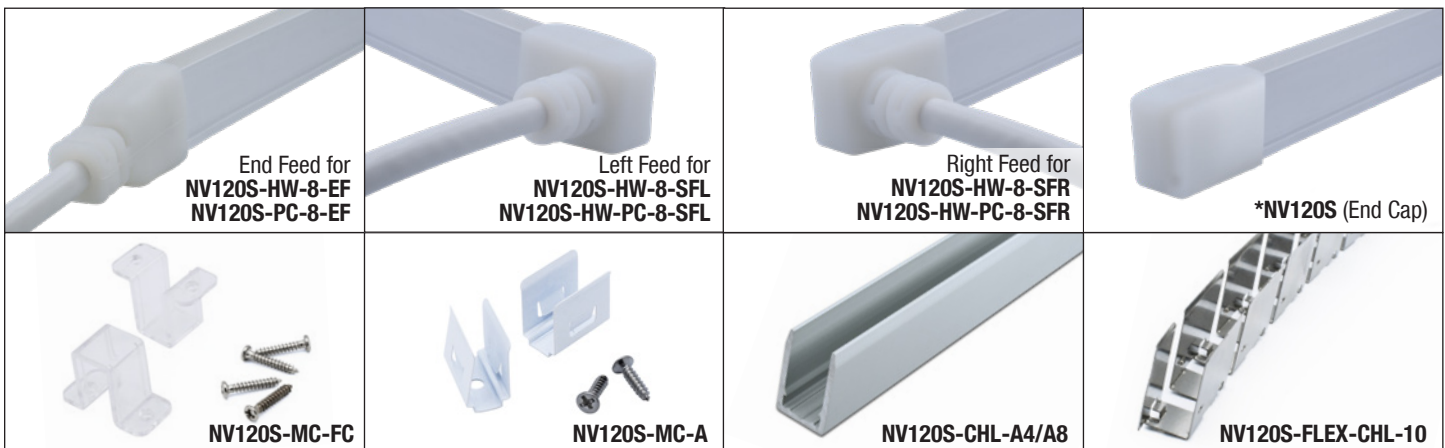

* Included with every tape section

NeoVision120 SideFlex

120VAC Neon LED Tape Specification Sheet



4. Pick Control Options

Lutron Dimmers	Family	Phase Dimming Operation	Trim Adjustments*	Smart Switch
Lutron PD-SNE	Casetta	Reverse Phase (ELV, use this setting only)	High & Low End Trim	Yes
Lutron DVELV	Diva	Reverse Phase (ELV)	-	-
Lutron DVRP	Diva	Reverse Phase (ELV)	-	-
Lutron MA-PRO	Maestro	Reverse Phase (ELV, recommended setting)	High & Low End Trim	-
Lutron RRD-PRO RadioRA2	Radio RA	Auto (recommended setting)	Low End Trim	Yes

Leviton Dimmers	Family	Phase Dimming Operation	Trim Adjustments*	Smart Switch
Leviton DSE06-10Z	Decora	Reverse Phase (ELV)	-	-
Leviton DDL06-1LZ	Decora	Forward Phase (TRIAC)	-	-

Legrand Dimmers	Family	Phase Dimming Operation	Trim Adjustments*	Smart Switch
Legrand RH703PTU	Radiant Harmony	Forward Phase (TRIAC, use this setting only)	High & Low End Trim	-

Notes: All dimmers operate at 120VAC, 60Hz
All dimmers will operate NV120 to below 20% dimming level.
Adjust trim levels for best performance.
See local electrical distributor for dimmers.



NeoVision120 SideFlex



120VAC Neon LED Tape Specification Sheet

End Feed for
NV120S-HW-8-EF
NV120S-PC-8-EF

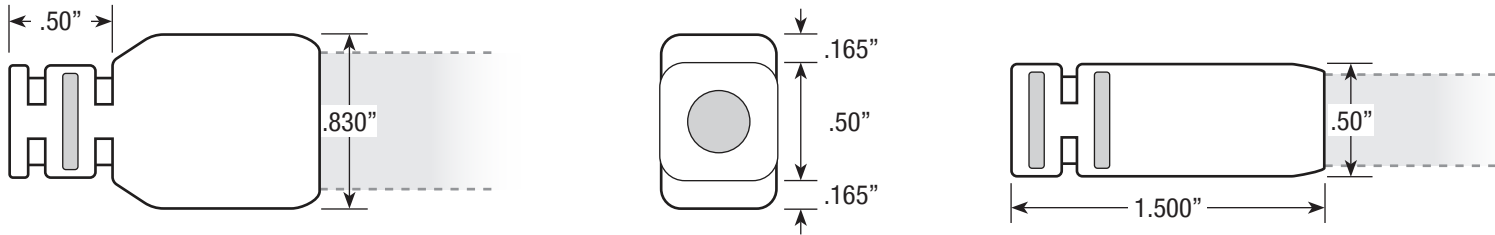

Left/Right Side Feed for
NV120S-HW-8-SFL/SFR
NV120S-PC-8-SFL/SFR

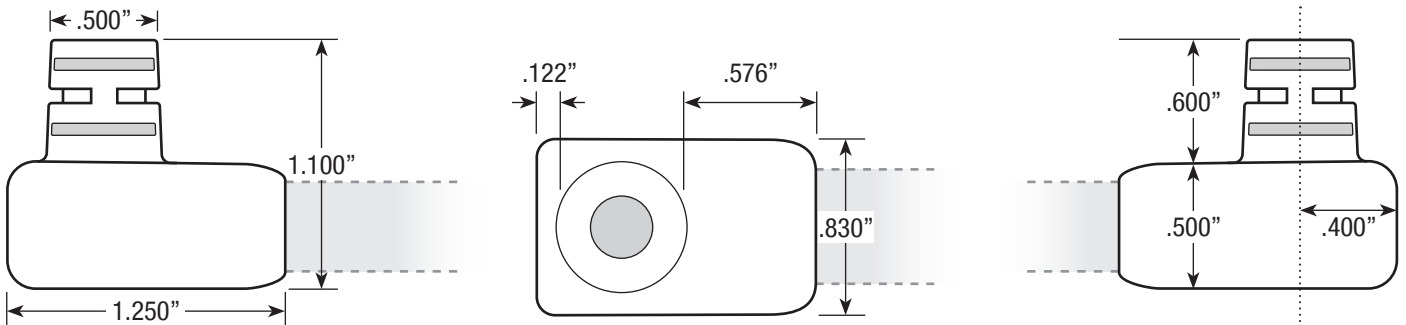

NV120S (End Cap)

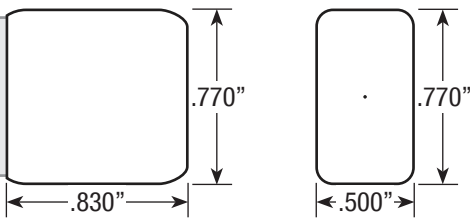

NV120S-MC-FC

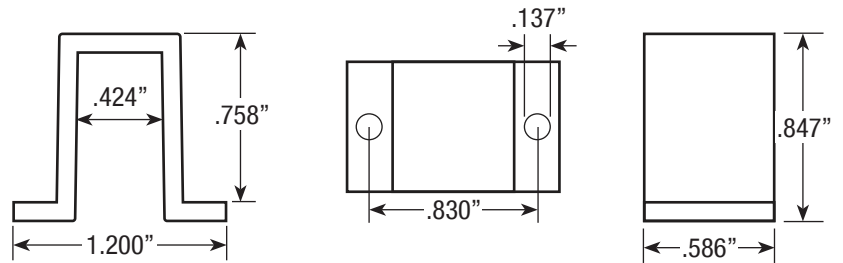

NV120S-MC-A

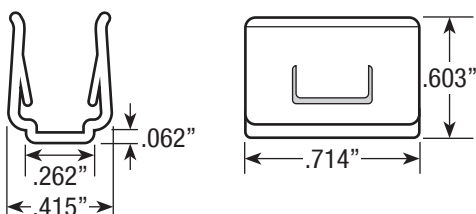

Rigid Channel
NV120S-CHL-A4/A8

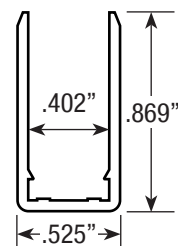

Flexible Channel
NV120S-FLEX-CHL-10

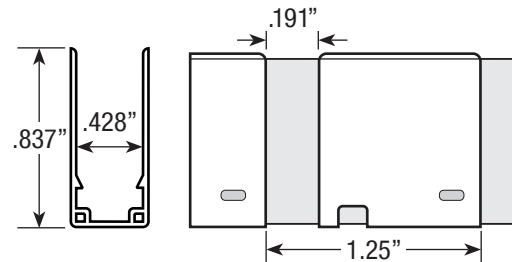

NeoVision120 SideFlex

120VAC Neon LED Tape Specification Sheet



DIMENSIONS

NV120S
Cross Section

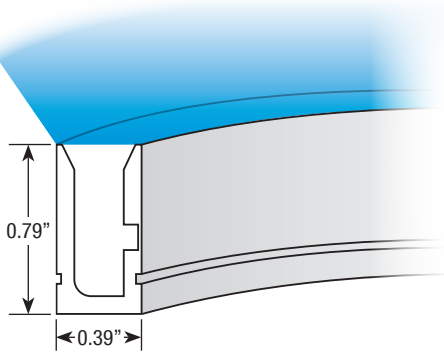

NV120S
Minimum Bending Diameter

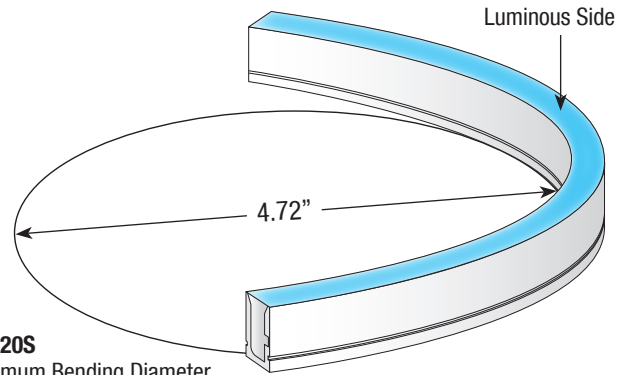

All parts pictured below are included with each hard wired option.

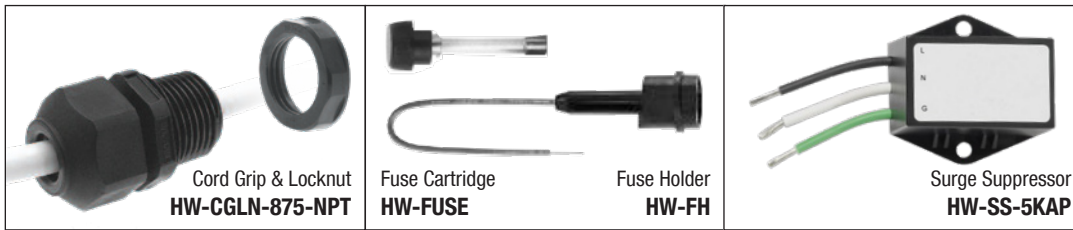

Cord Grip

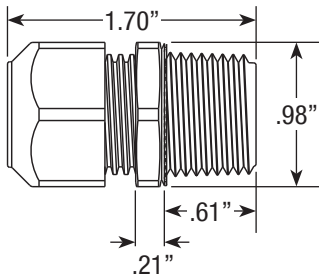

Locknut

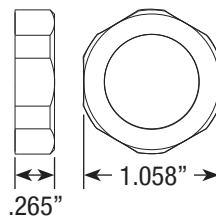

Surge Suppressor

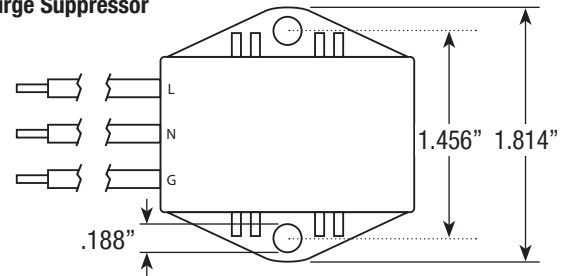

Fuse Cartridge

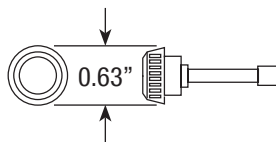

Fuse Holder

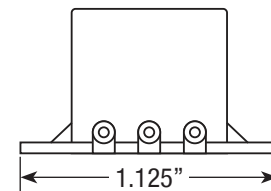
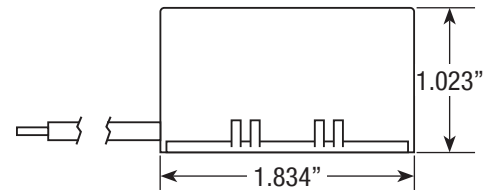
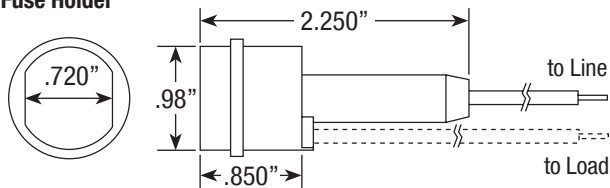

HARDWIRE ASSEMBLY

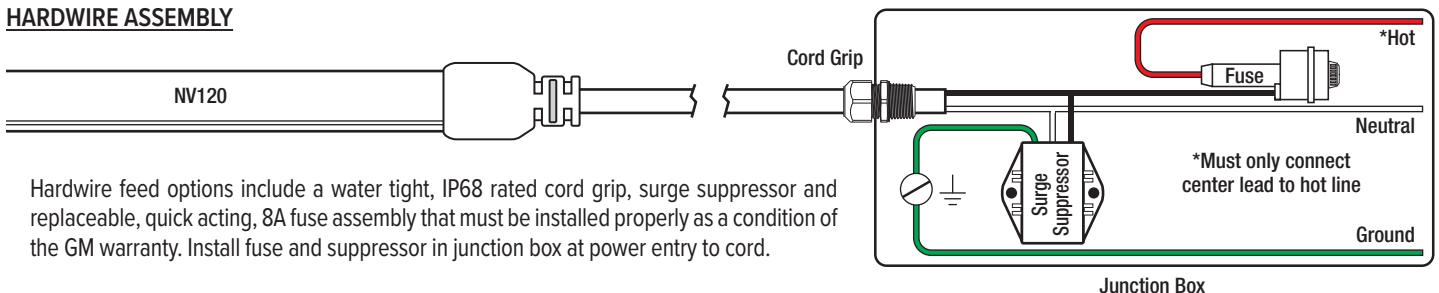

Hardwire feed options include a water tight, IP68 rated cord grip, surge suppressor and replaceable, quick acting, 8A fuse assembly that must be installed properly as a condition of the GM warranty. Install fuse and suppressor in junction box at power entry to cord.

NeoVision120 SideFlex

120VAC Neon LED Tape Specification Sheet

HARDWIRE FEEDS

NV120S-HW-8-EF (End Feed)

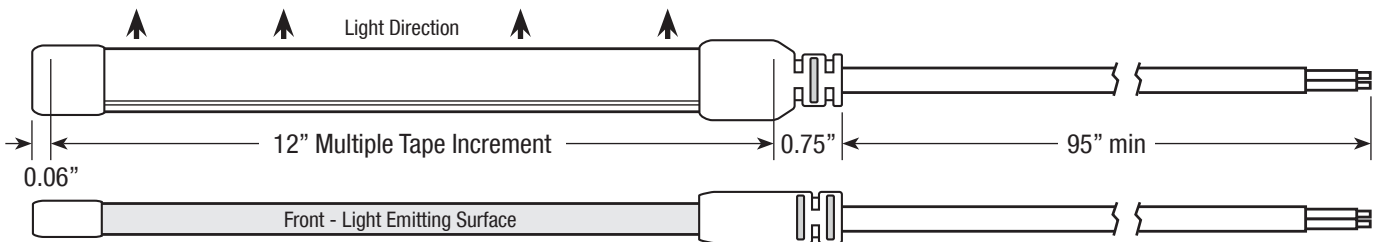

NV120S-HW-8-SFL (Side Feed - Left)

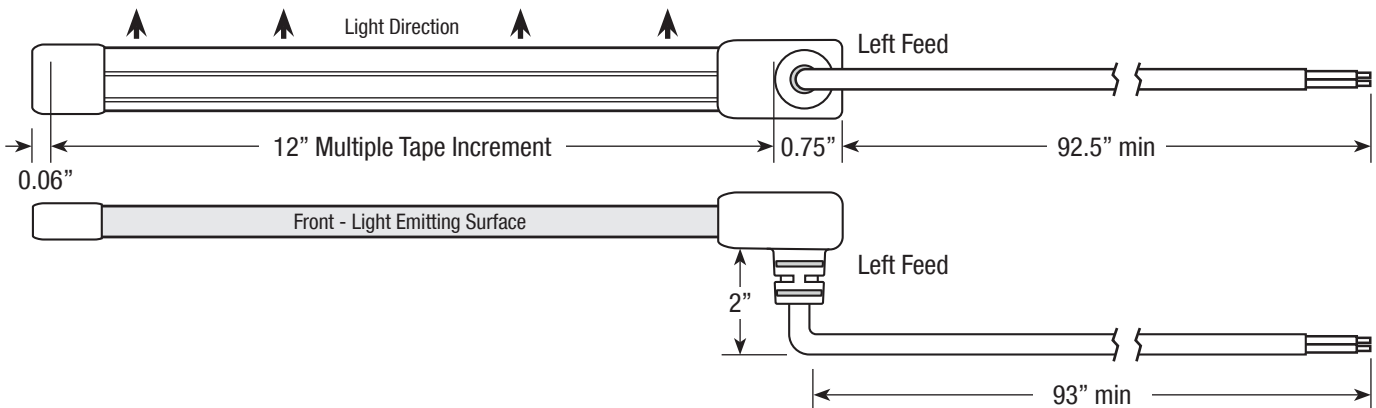

NV120S-HW-8-SFR (Side Feed - Right)

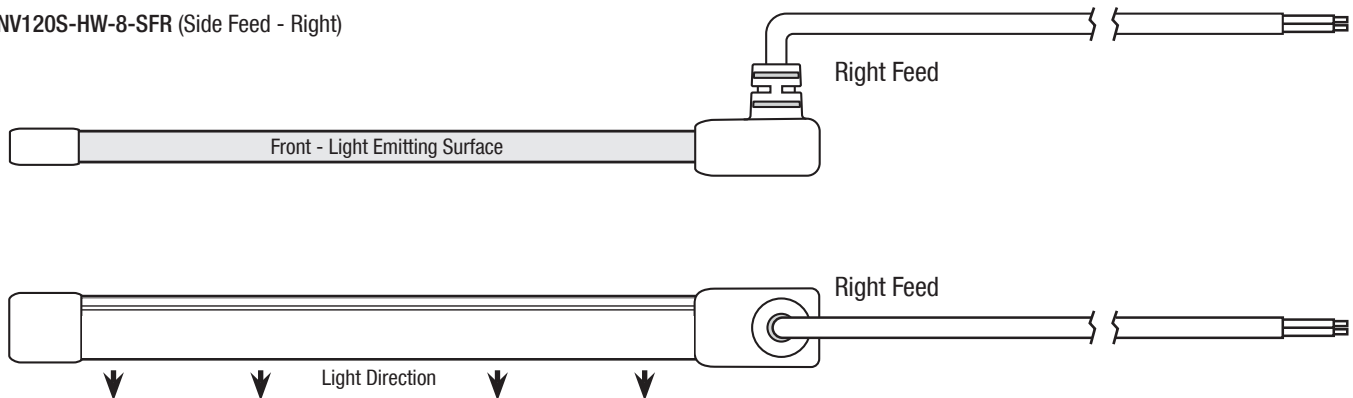

NeoVision120 SideFlex



120VAC Neon LED Tape Specification Sheet

CORD AND PLUG FEEDS

Each cord and plug assembly comes with a replaceable, quick acting, 8A fuse and built-in surge suppressor.
When routing cord, 1.5" dia. minimum clearance required for surge suppressor and plug.

NV120S-PC-8-EF (End Feed)

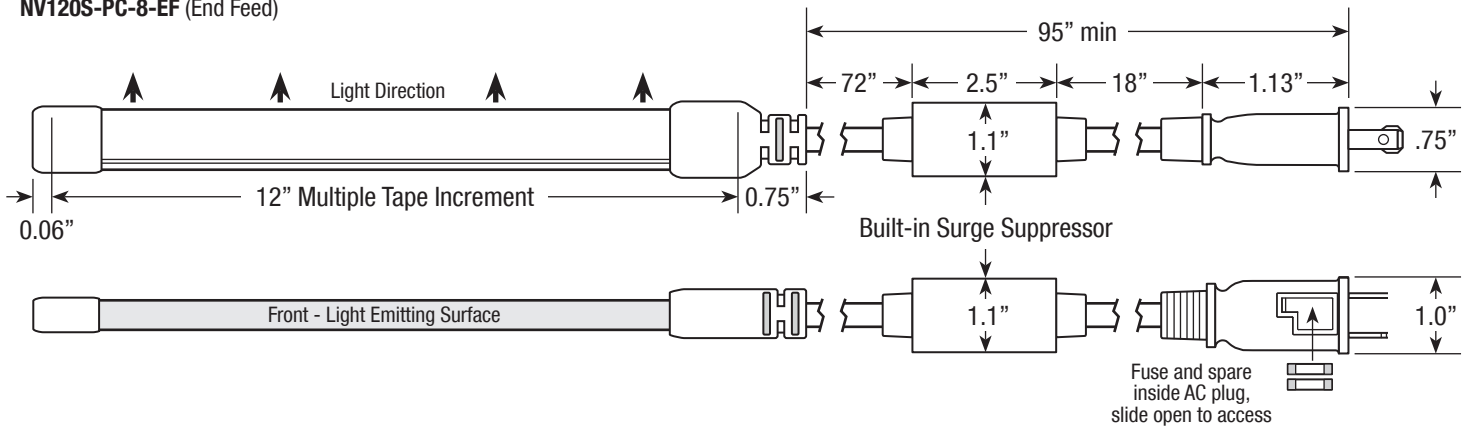

NV120S-PC-8-SFL (Side Feed - Left)

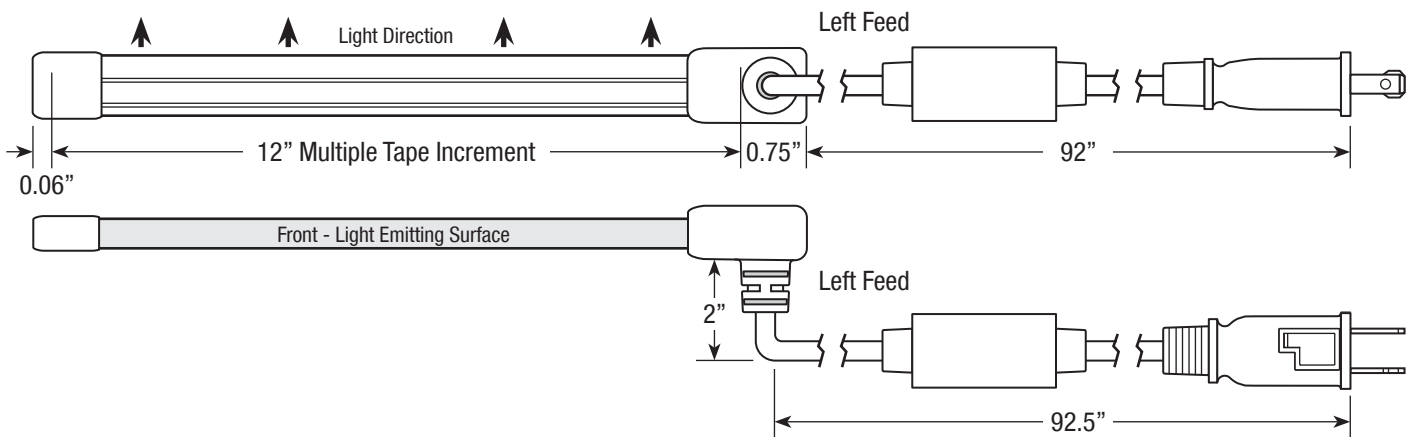

NV120S-PC-8-SFR (Side Feed - Right)

